



PRODUCT DETAILS

The BiANCO NXT SB4 oil filled 4" bore pumps are an excellent choice for delivering water reliably from bores or water wells for price sensitive customers.

Supplied with capacitor and NXT iProtect protection and control box

MOTOR FEATURES

- Asynchronous two-pole electric motor made entirely of stainless steel for the parts in contact with water.
- Oil filled rewindable filled with food grade white oil
- Heavy duty bearings
- Filter check valve and pressure equalising diaphragm
- Removable water bloc lead
- Industry standard NEMA mounting dimensions

WET-END FEATURES

- Floating Impeller Stack and Face Clearance Design allows sand and abrasive particles to pass freely ensuring optimum resistance against wear.
- Integrated thrust washer prevents face to face contact.
- High quality wear resistant composite materials and 304 grade SS bowls, discharge head/motor adapter and plate type NRV.
- NEMA spline and stainless steel shaft.

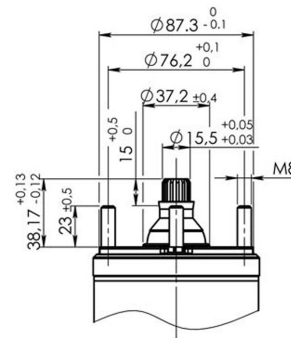

TECHNICAL DATA

RATED POWER (W)	1.1 kW
RATED VOLTAGE	230V +10% - 6% 50Hz
RATED CURRENT	9.1 amps
CAPACITOR	45uF
MAX LIQUID TEMPERATURE	40°C
MAX. IMMERSION DEPTH	IP68 - 100m
MOTOR DUTY	S1 Continuous
MOTOR PROTECTION LEVEL	Class F
SEALS	High Quality Mechanical Seal

MAX HEAD	133m
MAX FLOW	3m3/hr
MAX SAND CONTENT	250gm3
IMPELLERS	Glass filled Noryl
DIFFUSER	Glass filled Polycarbonate
NUMBER OF STAGES	20
LENGTH	Motor 390mm Wet-end 523mm
OUTLET	1.25" BSPF
WEIGHT (KG)	Motor 11kg Wet-end 5.3kg

CURVE

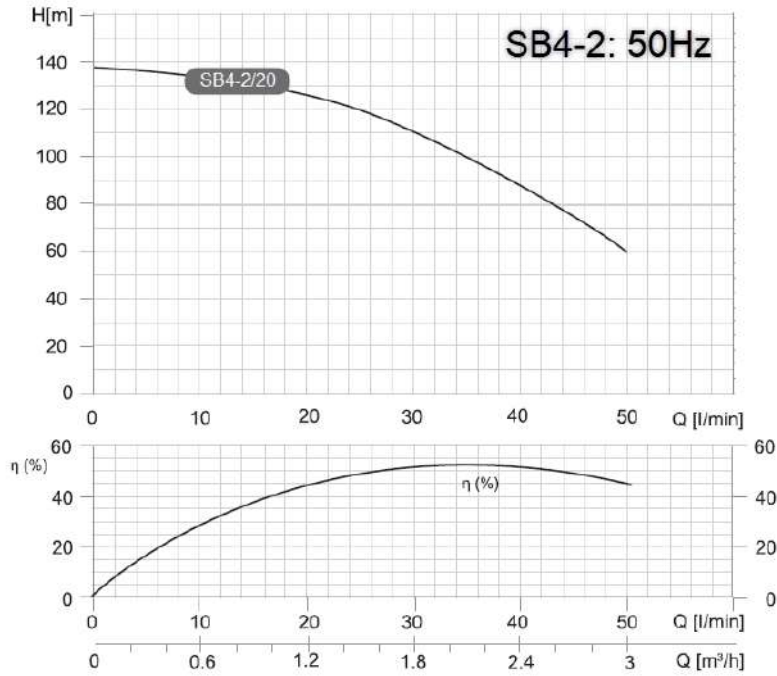

DIMENSIONS

1	Sleeve	SS
2 & 3	2: Lower support/motor adapter and 3: discharge head	Cast SS
4	Shaft with coupling	SS
5	Intermediate support	Glass filled composite
6	Bowl	SS
7	7: Impeller	Glass filled Noryl
8, 9	8: Diffusers 9: Top Diffuser	Glass filled Polycarbonate
10	Intermediate bearing	NBR
11 - 14	11: Shaft bushing 12: Top bushing 13: Adapter ring 14: NRV cap	SS
16	NVR support and O-ring	SS and NBR
17 - 23	17: NRV lock ring 18: Filter 19: Cable guard 21: Upper split ring 23: Thrust washer	SS

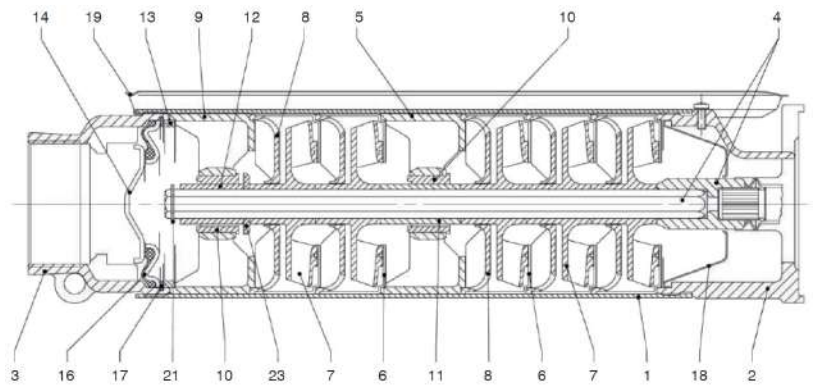

WARRANTY / CERTIFICATIONS

